

# Maintenance and infection control

## After every patient

### Surfaces

- 1 Wipe with Planmeca approved surface disinfectant:
  - metal parts of headrest
  - metal parts of armrests
  - front cover of the operating light
  - handles of the operating light
  - hygienic membrane
  - instrument hoses
  - instruments (see instrument instructions)
  - instrument console\*
  - balanced instrument arms
  - tray
  - cuspidor top cover
  - outside of the bowl
- 2 Wipe the upholstery with mild soap- and water solution. Wipe with Planmeca approved upholstery disinfectant if needed.
- 3 Wipe the monitor and the handle (see monitor instructions).
- 4 Clean the bowl:
  - Pour a few drops of Planmeca approved suction disinfectant into the bowl and use a soft brush.
  - Rinse the bowl by pressing the bowl rinse button.

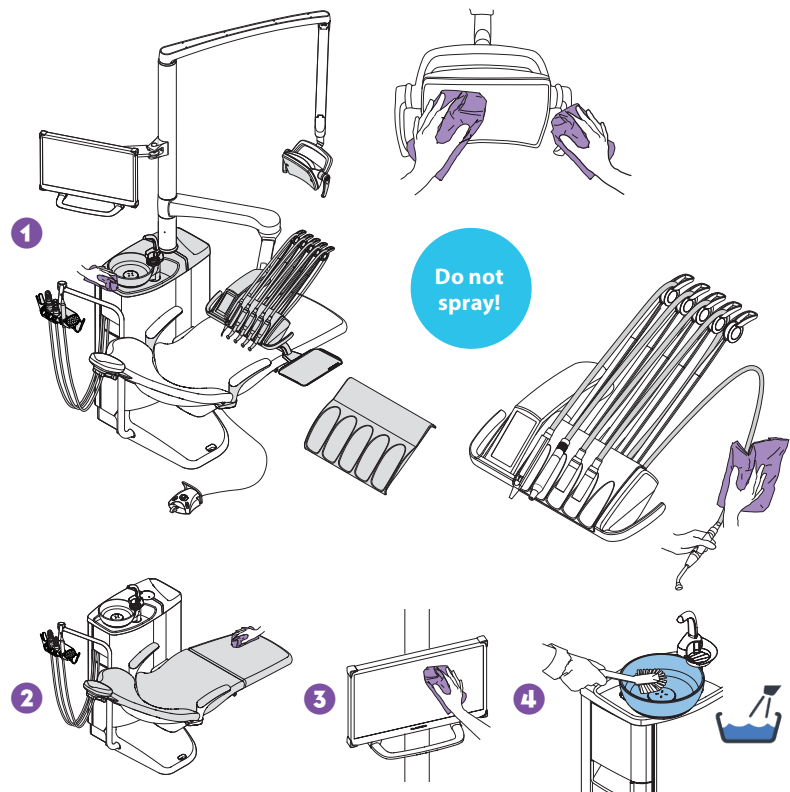

\*Before cleaning the instrument console, lock the touch screen.

Touch screen is unlocked. Press to lock.

Touch screen is locked. Press and hold to unlock.

Before covering the instrument console and touch screen with a protective cover (optional), make sure they are dry.

### Suction system

- 1 Remove used aspirating tips.
- 2 Rinse the suction tubes by aspirating one glass of water with each suction tube.
- 3 Wipe the suction handpieces with Planmeca approved surface disinfectant.
- 4 Wipe the suction holder with Planmeca approved surface disinfectant.

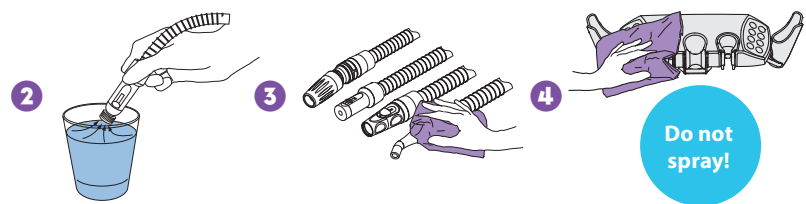

### Waterlines

#### Short flushing

- 1 Place all water consuming instruments into the flushing holder.
- 2 Bend the instrument arms to an angle of at least 90° and start short flushing.

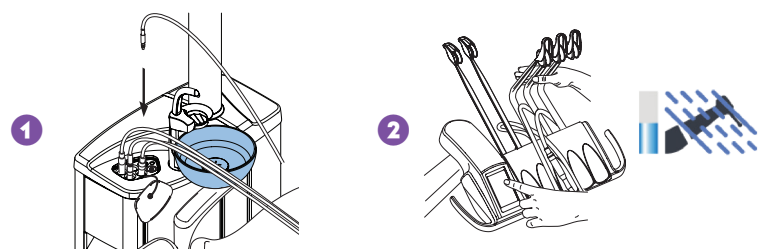

# In the morning

## Suction system

- 1 Rinse the suction tubes by aspirating 0.5 l of water with each suction tube.
- 2 Wipe the suction handpieces with Planmeca approved surface disinfectant.

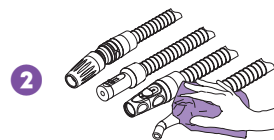
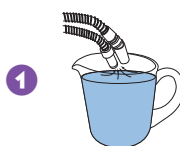

## Filters

Empty the disposable filters into a separate amalgam container.

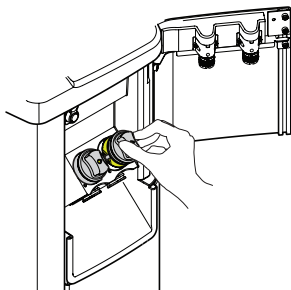

## Waterlines

### Long flushing

- 1 Place all water consuming instruments into the flushing holder.
- 2 Bend the instrument arms to an angle of at least 90° and start long flushing.

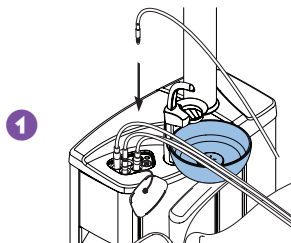

# After working day

## Surfaces

Wipe the upholstery with Planmeca approved upholstery disinfectant.

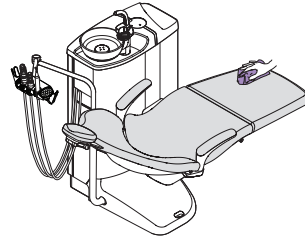

## Suction system

### Suction cleaning

- 1 Insert the suction tubes into the suction tube cleaning holder.
- 2 Start suction cleaning.
- 3 Disinfect the suction handpieces in a washer-disinfector.
- 4 Suction holder: Disinfect the individual holders in a washer-disinfector. Wipe the intraoral scanner holder with Planmeca approved surface disinfectant.

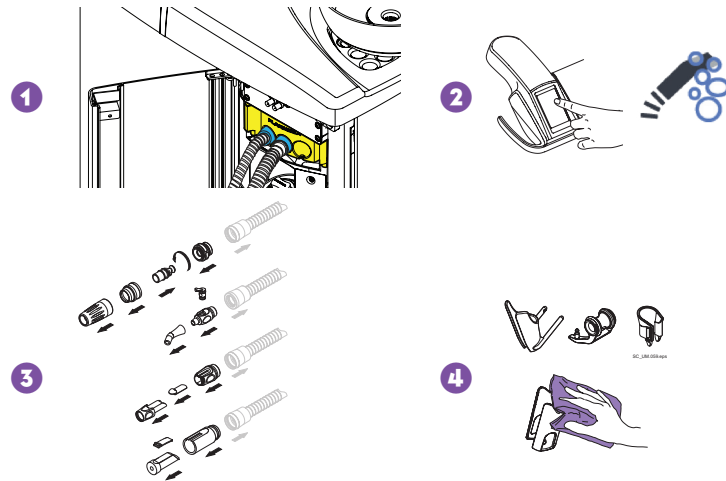

## Bowl

- 1 Empty, clean and disinfect the bowl filter in a washer-disinfector.  
*Attention! Do not empty the bowl filter to the drain.*
- 2 Remove the bowl and wash at max 65°C.

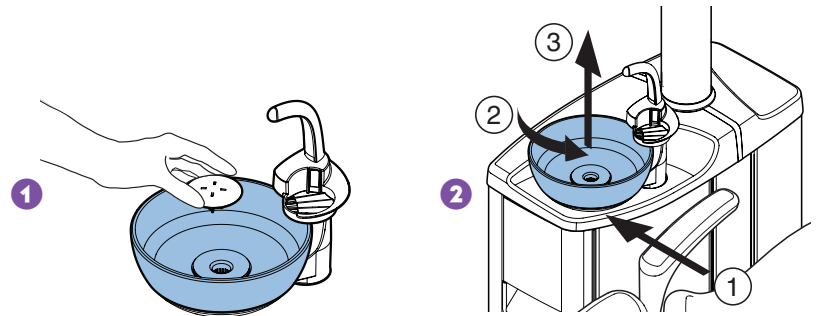

## Waterlines

### Long flushing

- 1 Place all water consuming instruments into the flushing holder.
- 2 Bend the instrument arms to an angle of at least 90° and start long flushing.

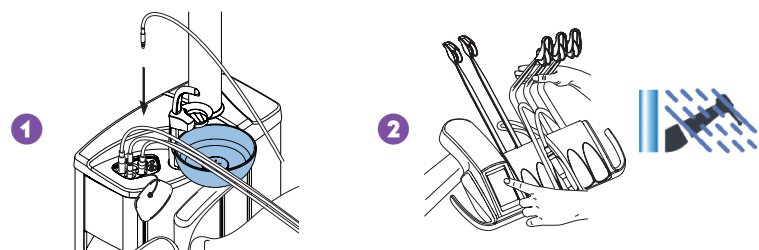

- 3 Switch off the unit.

# Weekly

## Surfaces

- 1 Wipe all surfaces with mild soap- and water solution.
- 2 Wipe the upholstery with Planmeca approved upholstery treating agent.

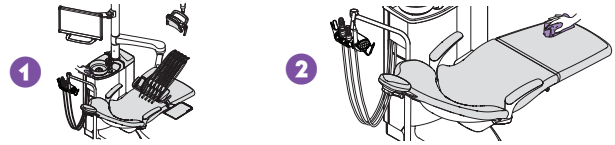

## Filters

- 1 Replace the disposable filters.



## Suction system

### Dürr separators or VS/A systems only

- 1 Mix 5 ml of Planmeca approved suction disinfectant with 250 ml of water.
- 2 Press the Program button for 5 s to open the bowl valve for 15 s to remove excess water.
- 3 When the valve has closed, pour the mixture into the bowl.
- 4 Let the solution affect overnight.



## Waterlines

### Waterline cleaning

- 1 Place all water consuming instruments into the flushing holder.
- 2 Bend the instrument arms to an angle of at least 90° and start waterline cleaning.
- 3 Close the water tap.
- 4 Fill the container with Planmeca approved waterline disinfectant. Attach the container to the unit. Follow the instructions on the display.
- 5 The next morning, switch the unit on.
- 6 Follow the instructions on the display.

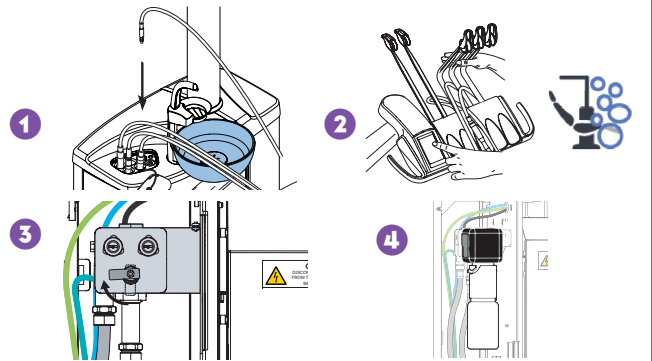

### Chlorine check for Planmeca ActiveAqua™

- 1 Measure the concentration of free chlorine in the water when H90.1 is displayed.
- 2 Select the corresponding value on the control panel.



# Monthly

## Suction system and waterlines

- 1 Disinfect the instrument flushing holder in a washer-disinfector. Autoclave if needed.
- 2 Disinfect the suction tube cleaning holder in a washer-disinfector.
- 3 CAS1 suction system: Replace the amalgam collector when H1 is displayed on the dental unit's control panel. Other suction systems with deposit cup: Check and empty the deposit cup when 70% full.

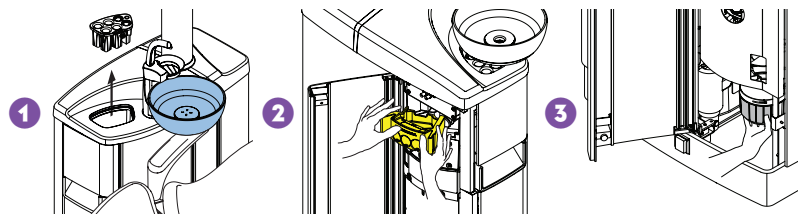

## Filters

- 1 Press the Program button for 5 sec. to empty the bowl valve. Then, empty the spittoon valve coarse filter into a separate amalgam container.
- 2 Empty the oil collector.

